

**STX300 RUNNING BOARD BRACKET KIT  
09-14 DODGE RAM 1500 QUAD & CREW CABS  
10-14 25-3500 QUAD & CREW CABS**

**PARTS LIST:**

|   |  |    |                                   |
|---|--|----|-----------------------------------|
| 2 | Driver/Left Front and Center Mounting Brackets     | 6  | 12mm Hex Nuts                     |
| 2 | Passenger/Right Front and Center Mounting Brackets | 6  | 10-1.5mm x 35mm Hex Bolts         |
| 2 | Driver/Left Front and Center Support Brackets      | 6  | 10mm x 27mm OD x 3mm Flat Washers |
| 2 | Passenger/Right Front and Center Support Brackets  | 6  | 10mm Lock Washers                 |
| 1 | Driver/Left Rear Mounting Bracket                  | 12 | 8-1.25mm x 25mm Hex Bolt          |
| 1 | Passenger/Right Rear Mounting Bracket              | 24 | 8mm x 24mm x 2mm Flat Washer      |
| 1 | Driver/Left Rear Support Bracket                   | 12 | 8-1.25mm Nylon Lock Nuts          |
| 1 | Passenger/Right Rear Support Bracket               | 12 | 6mm T-Bolts                       |
| 6 | 12mm x 35mm Bolt x 10mm Nut Plates                 | 12 | 6mm x 22mm OD x 2mm Flat Washers  |
| 6 | 12mm Plastic Retainers                             | 12 | 6mm Lock Washers                  |
| 6 | 12mm x 32mm OD x 3mm Flat Washers                  | 12 | 6mm Hex Nuts                      |
| 6 | 12mm Lock Washers                                  |    |                                   |

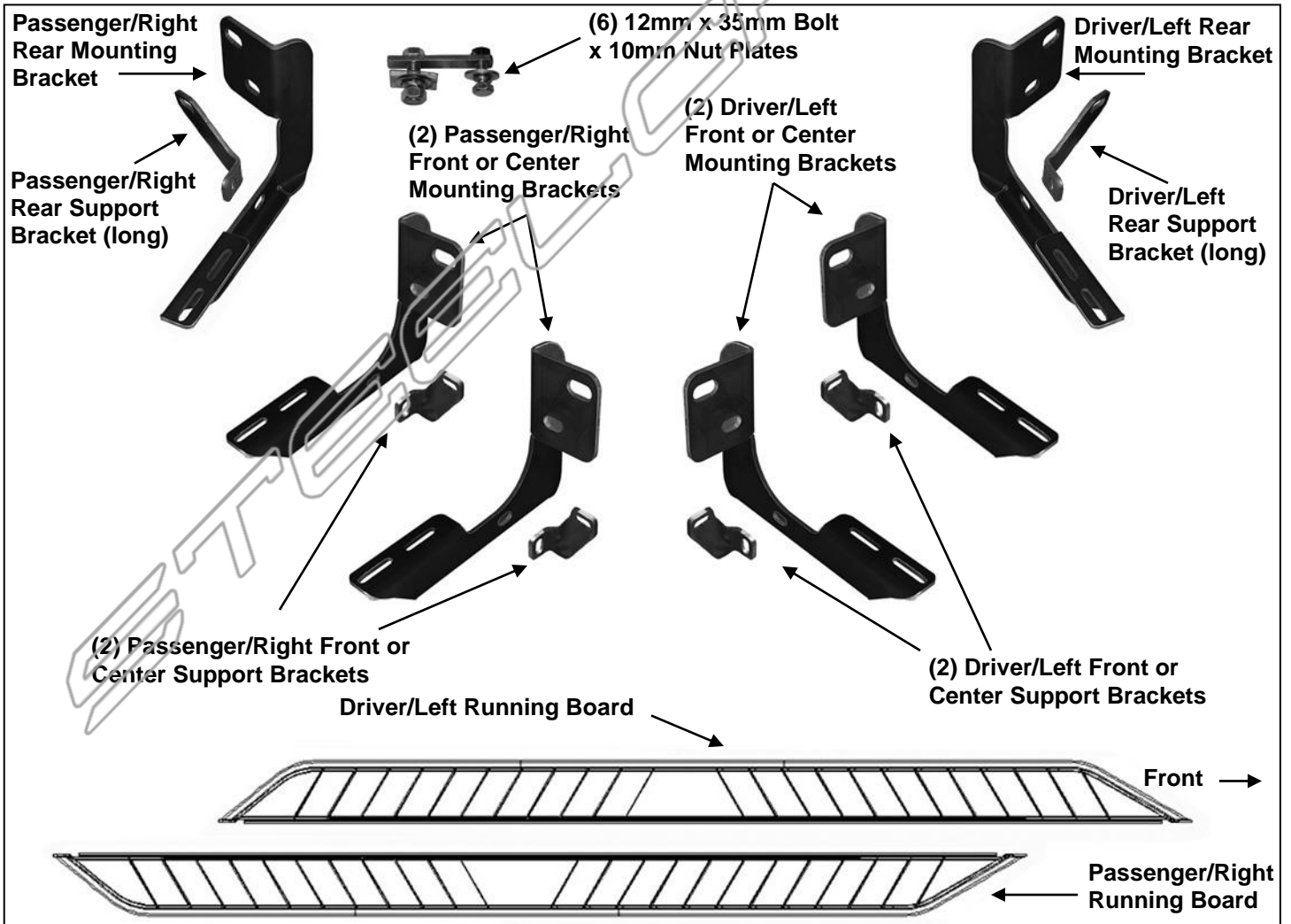

**STX300 RUNNING BOARD BRACKET KIT**  
**09-14 DODGE RAM 1500 QUAD & CREW CABS**  
**10-14 25-3500 QUAD & CREW CABS**

**PROCEDURE:**

**REMOVE CONTENTS FROM BOX. VERIFY ALL PARTS ARE PRESENT. READ INSTRUCTIONS CAREFULLY BEFORE STARTING INSTALLATION. DRILLING IS REQUIRED ON 2009-12 1500, 2010-12 25-3500 MODELS.**

1. Starting at the passenger side-front of the vehicle, remove the sealing tape covering the factory holes in the side of the inner panel, **(Figure 1)**. Partially thread (1) 12mm Plastic Retainer onto the threaded end of (1) 12mm Bolt and Nut Plate, **(Figure 2A)**. Insert the Bolt and Nut Plate into the factory oval hole. Continue to thread the Plastic Retainer down the Bolt until it is flush against the sheet metal, **(Figure 2B)**. **NOTE:** When properly installed, the Plastic Retainer is designed to help hold the Bolt and Nut Plate in place during Bracket installation. Use is not mandatory for installation.
2. Select the passenger side front Mounting Bracket, **(Figure 3)**. Attach the Bracket to the Bolt and Nut Plate with (1) 12mm Flat Washer, (1) 12mm Lock Washer and (1) 12mm Hex Nut. Do not tighten hardware at this time, **(Figure 4)**.
3. Line up the remaining hole in the Mounting Bracket with the hole in the body panel. Rotate the Bolt and Nut Plate until the threaded end (Nut) lines up with the hole in the Mounting Bracket and body panel, **(Figure 2B)**. Bolt the Bracket to the nut with (1) 10mm x 35mm Hex Bolt, (1) 10mm Lock Washer and (1) 10mm Flat Washer, **(Figure 4)**. Snug but do not tighten hardware at this time.
4. Move along the side of the vehicle to the center mounting location below where the front and rear doors meet, **(Figure 5)**. Repeat **Steps 1—3** to install the center Mounting Bracket, **(Figure 15)**.
5. Continue along the side to the mounting location at the rear of the cab, **(Figure 7)**. Repeat **Steps 1—3** to install the passenger side Rear Mounting Bracket, **(Figures 8 & 9)**. **NOTE:** The Rear Mounting Brackets may look similar to the other Brackets but they are unique. Use the illustration on **Page 1** and **Figure 3** to properly identify the front, center and rear Brackets.
6. Once all (3) Brackets have been installed, select the passenger side Running Board. **NOTE:** Angled end of Running Board is the front, **(see Page 1)**. Locate the two channels in the bottom of the Running Board. (3) 6mm T-Bolts are required for each channel. Slide (3) T-Bolts into each channel, **(Figure 10)**.
7. Hold the Running Board up in approximate position and slide the T-Bolts along the channel to line up with the (3) Mounting Brackets. Tilt the Board up at a slight angle and push back against the vehicle until the T-Bolts fit into the slots in the Brackets.
8. Secure the Running Board to the Brackets with (6) 6mm Flat Washers, (6) 6mm Lock Washers and (6) 6mm Hex Nuts, **(Figures 13 & 16)**. Leave hardware loose at this time. **NOTE:** The Running Board is designed to fit close to the vehicle. It may be necessary to loosen the Bracket hardware and tilt the Brackets downward to insert the Running Board between the Brackets and the body. Do not fully tighten hardware at this time.
9. Move to the front Bracket location. Select (1) passenger/right front or center Support Bracket, **(Figure 11)**. Bolt the bent end of the Bracket to the front of the Mounting Bracket with (1) 8mm Hex Bolt, (2) 8mm Flat Washers and (1) 8mm Nylon Lock Nut, **(Figure 12)**. Leave loose at this time.
10. Line up the flat end of the Support Bracket with the underside of the body and flat against the back of the pinch weld. Repeat this Step to install the center and longer rear Support Brackets, **(Figure 13)**.
11. Select the appropriate installation for your vehicle.  
**2009-12 models without holes in pinch weld:**
  - a) Adjust Mounting Brackets up or down to level the Running Board with the Support Brackets above the bottom edge of the pinch weld. Mark the location of the hole in the Support Bracket onto the back of the pinch weld, **(Figures 12 & 13)**. **IMPORTANT:** Make sure that you do not mark or drill too close to the edge of the pinch weld.
  - b) Repeat as necessary to line up and mark all (3) Support Bracket locations.
  - c) Move the (3) Support Brackets out of the way. Use a 5/16" (or 8mm) drill bit to drill through the pinch weld for all (3) Support Brackets. **IMPORTANT:** Do not drill for Support Brackets until after the Running Board has been completely installed and adjusted. Any cutting or drilling tool may break or shatter. Government regulations require safety glasses & equipment at all times when cutting or drilling.
  - d) Bolt each Support Bracket to the back of the pinch weld with (1) 8mm Hex Bolt, (2) 8mm Flat Washers and (1) 8mm Nylon Lock Nut, **(Figures 14—16)**. Do not tighten hardware at this time.

**STX300 RUNNING BOARD BRACKET KIT  
09-14 DODGE RAM 1500 QUAD & CREW CABS  
10-14 25-3500 QUAD & CREW CABS**

**2013-14 models with factory holes through pinch weld:**

- a) Line up the slot in the Support Bracket with the factory hole in the pinch weld.
  - b) Bolt each Support Bracket to the back of the pinch weld with (1) 8mm Hex Bolt, (2) 8mm Flat Washers and (1) 8mm Nylon Lock Nut, (**Figures 14—16**). Do not tighten hardware at this time.
- 12.** Level and adjust the Running Board and fully tighten all hardware.  
**13.** Repeat **Steps 1—12** for the driver/left side Running Board installation.  
**14.** Do periodic inspections to the installation to make sure that all hardware is secure and tight.

**To protect your investment**, wax this product after installing. Regular waxing is recommended to add a protective layer over the finish. Do not use any type of polish or wax that may contain abrasives that could damage the finish.

**For stainless steel:** Aluminum polish may be used to polish small scratches and scuffs on the finish. Mild soap may be used also to clean the Running Board.

**For gloss black finishes:** Mild soap may be used to clean the Running Board.

**Passenger Side Installation Pictured**

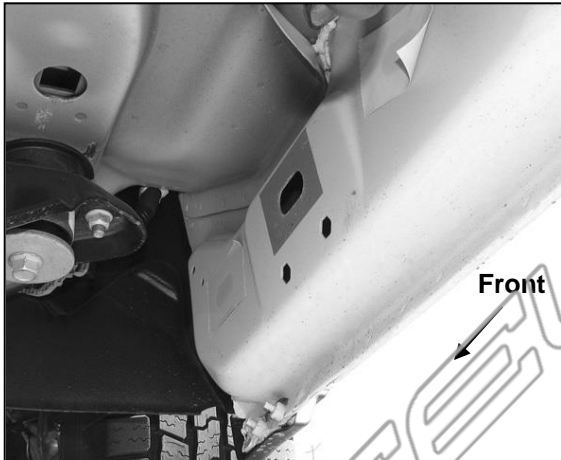

**(Fig 1) Passenger/right front mounting location (09-12 model pictured before drilling)**

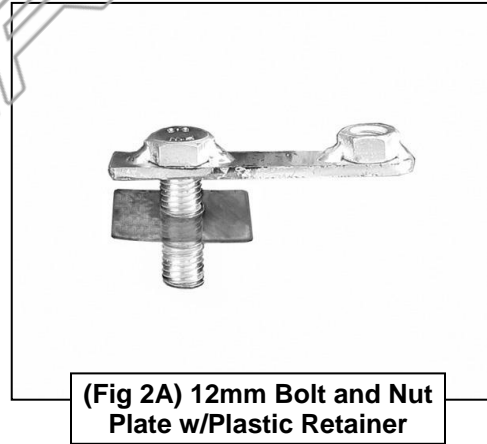

**(Fig 2A) 12mm Bolt and Nut Plate w/Plastic Retainer**

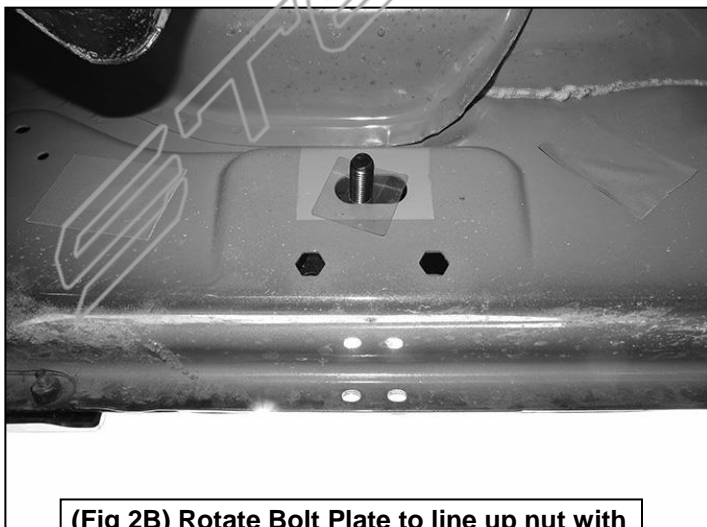

**(Fig 2B) Rotate Bolt Plate to line up nut with correct mounting holes, (2013-on pictured-Note factory holes in pinch weld)**

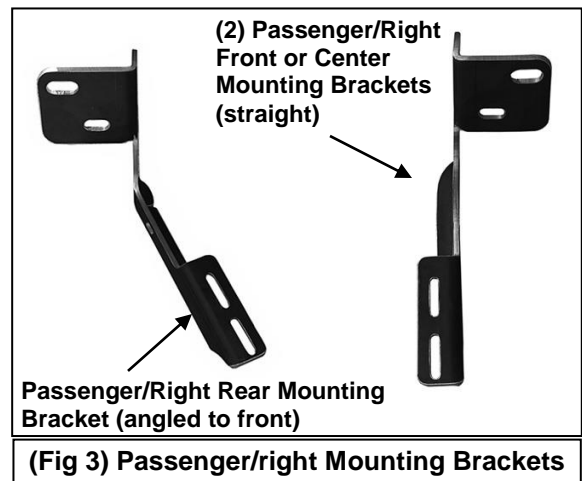

**(Fig 3) Passenger/right Mounting Brackets**

**STX300 RUNNING BOARD BRACKET KIT  
09-14 DODGE RAM 1500 QUAD & CREW CABS  
10-14 25-3500 QUAD & CREW CABS**

**Passenger Side Installation Pictured**

12mm Flat Washer  
12mm Lock Washer  
12mm Hex Nut

10mm x 35mm Hex Bolt  
10mm Lock Washer  
10mm Flat Washer



**(Fig 4) 2013-on Passenger/right front Bracket**

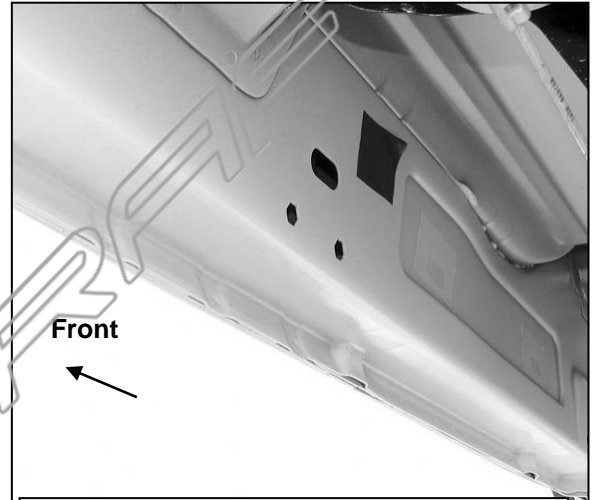

**(Fig 5) Passenger/right center location  
(09-12 model pictured before drilling)**

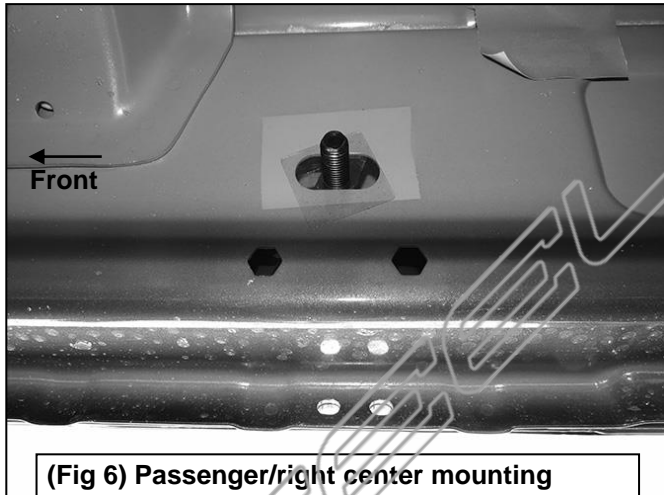

**(Fig 6) Passenger/right center mounting  
location (2013-on pictured with factory holes)**



**(Fig 7) Passenger/right rear mounting location**

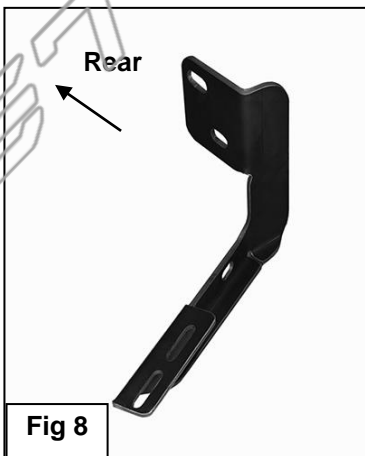

**Fig 8**

**Passenger/right rear  
Mounting Bracket (note  
bracket angled forward)**

**STX300 RUNNING BOARD BRACKET KIT  
09-14 DODGE RAM 1500 QUAD & CREW CABS  
10-14 25-3500 QUAD & CREW CABS**

**Passenger Side Installation Pictured**

10mm x 35mm Hex Bolt  
10mm Lock Washer  
10mm Flat Washer

12mm Flat Washer  
12mm Lock Washer  
12mm Hex Nut

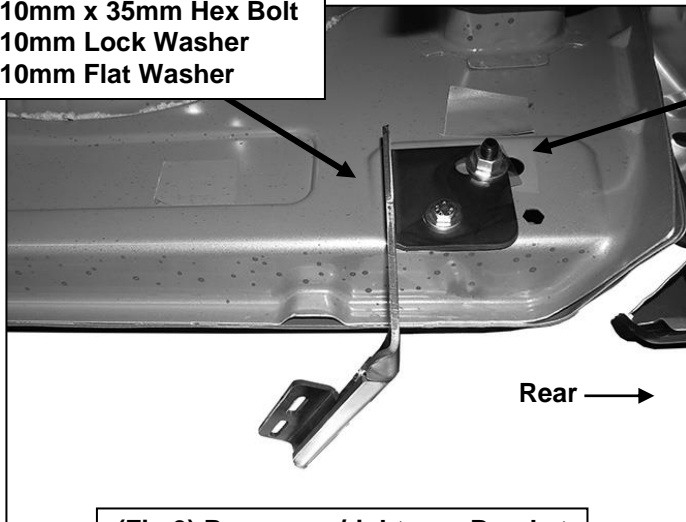

**(Fig 9) Passenger/right rear Bracket**

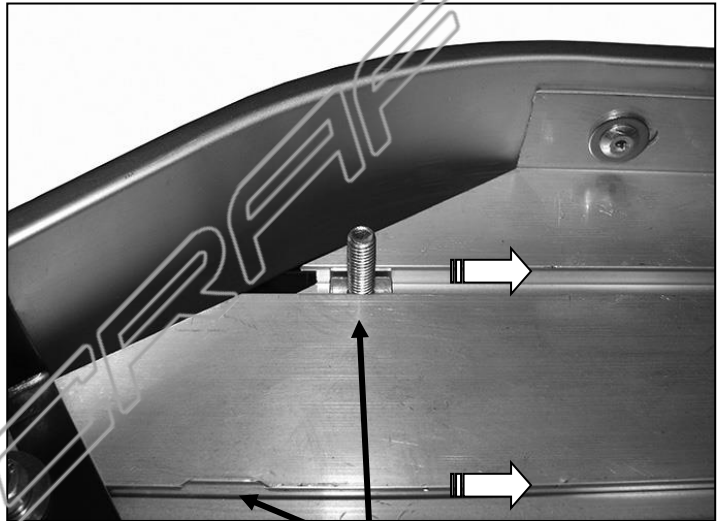

**(Fig 10) Slide 6mm T-Bolts into channels**

(2) Passenger/right Front or  
Center Support Brackets

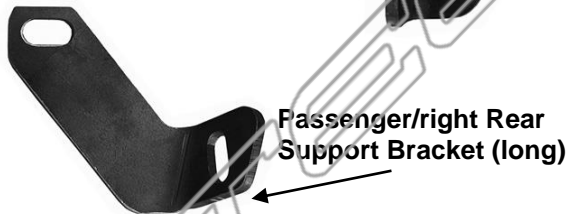

**(Fig 11) Passenger/right Support Brackets**

2009-12 models: Mark the Support  
Bracket location onto back of pinch weld.  
Drill 5/16" hole through pinch weld.

2009-12 models only: Do not mark  
or drill holes until after Running  
Board has been installed, properly  
adjusted and Mounting Bracket to  
Bolt Plate hardware fully tightened.

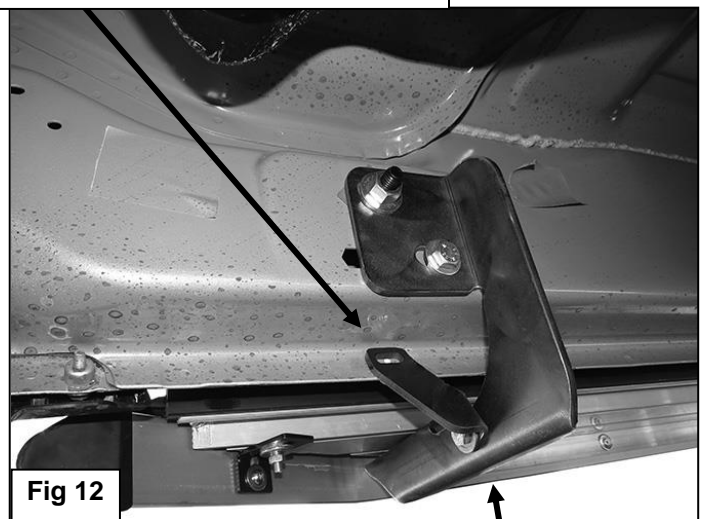

**Fig 12**

8mm x 25mm Hex Bolts  
(2) 8mm Flat Washers  
8mm Lock Washers

**STX300 RUNNING BOARD BRACKET KIT**  
**09-14 DODGE RAM 1500 QUAD & CREW CABS**  
**10-14 25-3500 QUAD & CREW CABS**

**Passenger Side Installation Pictured**



**(Fig 13) Passenger/right rear Support Bracket (long)**

**2009-12 models: Mark the Support Bracket location onto back of pinch weld. Drill 5/16" hole through pinch weld.**

**8mm x 25mm Hex Bolts**  
**8mm Flat Washers**  
**8mm Lock Washers**

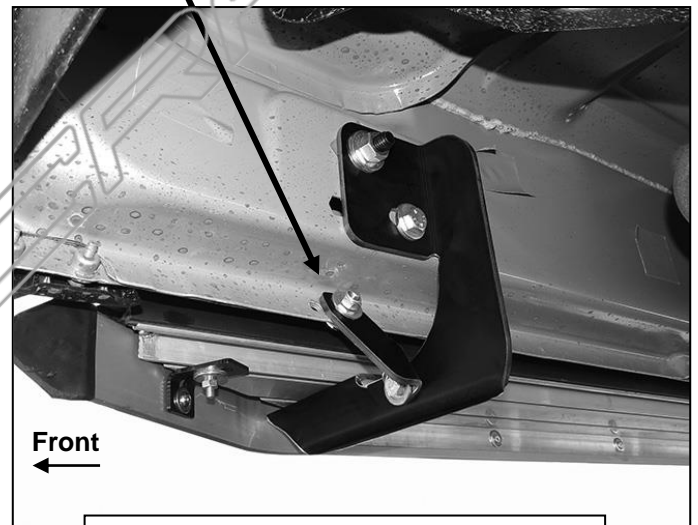

**(Fig 14) Passenger/right front Bracket**

**8mm x 25mm Hex Bolts**  
**8mm Flat Washers**  
**8mm Lock Washers**



**(Fig 15) Passenger/right center Bracket**

**6mm T-Bolts**  
**6mm Flat Washers**  
**6mm Lock Washers**  
**6mm Hex Nuts**

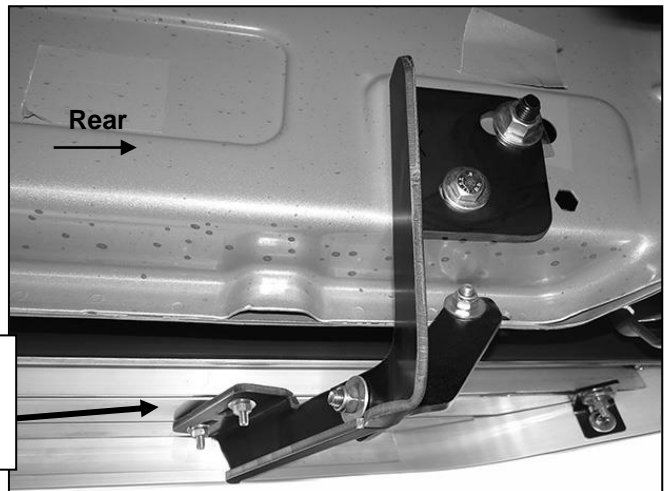

**(Fig 16) Passenger/right rear Bracket**